



Chirurgia Surgical



MADE IN ITALY

Set di Strumenti per la Chirurgia Orale Instruments Kit for Oral Surgery

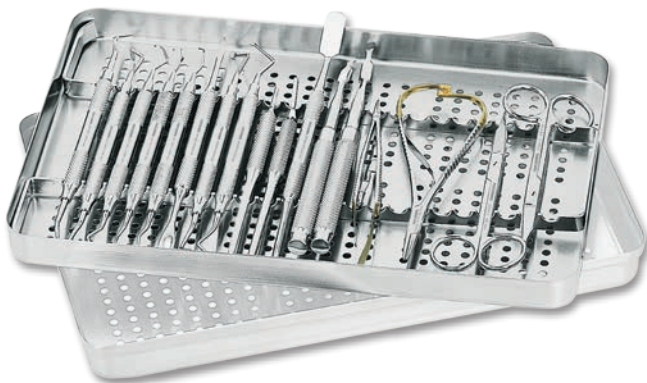

S3002-18

Contenuto/Contents:

MV1807-08	Curette Gracey / <i>Gracey Curette</i>
MV1807-12	Curette Gracey / <i>Gracey Curette</i>
MV1807-14	Curette Gracey / <i>Gracey Curette</i>
0304-1	Forbicina Goldman-Fox retta / <i>Straight Goldman-Fox scissors</i>
0304-2	Forbicina Goldman-Fox curva / <i>Curved Goldman-Fox scissors</i>
MV2001-85	Cucchiaio alveolare Lucas / <i>Lucas Bone Curette</i>
MV2001-86	Cucchiaio alveolare Lucas / <i>Lucas Bone Curette</i>
MV1803-D	Bisturi Kirkland / <i>Kirkland Knives</i>
MV1804-D	Bisturi Orban / <i>Orban Knives</i>
MV1850-M9	Scollaperiosteo Molt / <i>Molt Periosteal elevator</i>
MV1851-PR3	Scollaperiosteo Prichard / <i>Prichard Periosteal elevator</i>
0350-5	Manico per bisturi retto / <i>Straight scalpel handle</i>
0350-5A	Manico per bisturi curvo / <i>Curved scalpel handle</i>
1800-1	Scalpello Ochsenbein / <i>Ochsenbein Chisel</i>
1800-2	Scalpello Ochsenbein / <i>Ochsenbein Chisel</i>
0445-14 TC	Porta aghi Castroviejo / <i>Castroviejo Needle holder</i>
0435-14 TC	Porta aghi Mathieu / <i>Mathieu Needle holder</i>
S2722-2	Vassoio / <i>Tray</i>



S3002-17

Contenuto/Contents:

2102-IN	Manico per specchietti / <i>Mouth mirror handle</i>
0700-23	Sonda / <i>Explorer</i>
0601-2	Pinzetta per medicazione London College / <i>London College cotton and dressing pliers</i>
0631-1	Pinzetta chirurgica Semken-Taylor / <i>Semken-Taylor tissue pliers</i>
1815-7	Bisturi Goldman-Fox / <i>Goldman-Fox knives</i>
1804 D	Bisturi Orban / <i>Orban knives</i>
MV1850-M9	Scollaperiosteo Molt / <i>Molt periosteal elevator</i>
MV1851-PR3	Scollaperiosteo Prichard / <i>Prichard periosteal elevator</i>
2616-1	Divaricatore Farabeuf / <i>Farabeuf retractor</i>
2602-1	Divaricatore Sternberg / <i>Sternberg retractor</i>
2613-2	Divaricatore Senn-Miller / <i>Senn-Miller retractor</i>
0415-15TC	Porta aghi Crile-Wood / <i>Crile-Wood needle holder</i>
0430-14	Porta aghi Mathieu / <i>Mathieu needle holder</i>
0304-2	Forbicina Goldman-Fox / <i>Goldman-Fox scissors</i>
0500-1	Pinza emostatica Halstead-Mosquito retta / <i>Straight Halstead-Mosquito haemostatic forceps</i>
0500-2	Pinza emostatica Halstead-Mosquito curva / <i>Curved Halstead-Mosquito haemostatic forceps</i>
2200-5	Specchietto / <i>Mouth mirror</i>
S2722-1	Vassoio / <i>Tray</i>



S3002-13

Contenuto/Contents:

0602-2	Pinzetta per medicazione / <i>Cotton and dressing pliers</i>
0635-3	Pinzetta per chirurgia / <i>Tissue pliers</i>
0625-1	Pinzetta per sutura / <i>Suture pliers</i>
2611-2	Divaricatore / <i>Retractor</i>
0430-14	Porta aghi Mathieu / <i>Mathieu needle holder</i>
0441-14	Porta aghi Castroviejo / <i>Castroviejo needle holder</i>
0350-3	Manico per bisturi / <i>Scalpel handle</i>
0320-2	Forbice per chirurgia Spencer retta / <i>Straight Spencer surgical scissors</i>
0321-2	Forbice per chirurgia Metzenbaum curva / <i>Curved Metzenbaum surgical scissors</i>
2102-IN	Manico per specchietto / <i>Mouth mirror handle</i>
2607	Divaricatore Buchwald / <i>Buchwald retractor</i>
2200-4	Specchietto / <i>Mouth mirror</i>
S2722-1	Vassoio / <i>Tray</i>



Forbicine per Gengive
Gum Scissors



0300-1
Fig. 1
cm. 12

Rette
Straight



Curve
Curved
0300-2
Fig. 2



0301-1
Fig. 1
cm. 11,5

Angolari
Angular



0301-2
Fig. 2

Angolari, una
punta dentata
Angular, one
blade serrated



0305-1
Fig. 1
Iris
cm. 11,5

Rette
Straight



Curve
Curved
0305-2
Fig. 2
Iris



0305-3
Fig. 3
Iris



0305-1TC
Fig. 1TC
Iris
cm.11

Rette
Straight



Curve
Curved
0305-2TC
Fig. 2TC
Iris
cm.11

Con inserti al carburo
di tungsteno
With tungsten
carbide inserts

Forbicine per Gengive Gum Scissors



0304-1
Fig. 1
Goldman-Fox
cm. 13

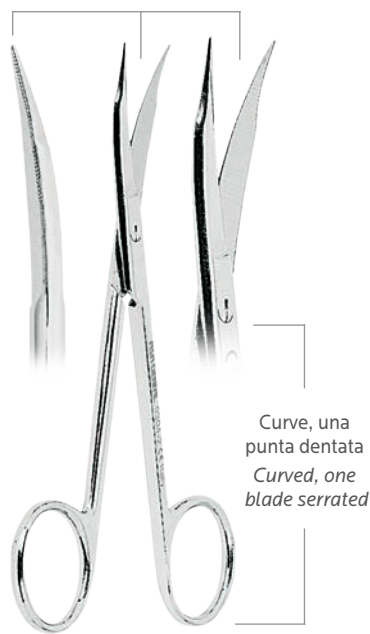

0304-2
Fig. 2
Goldman-Fox
cm. 13



0304-3
Fig. 3
Goldman-Fox (special)
cm. 13



0304-1TC
Fig. 1TC
Goldman-Fox
cm.13

Con inserti al carburo di tungsteno
With tungsten carbide inserts



0304-2TC
Fig. 2TC
Goldman-Fox
cm.13



0304-1TC
Forbici dritte Goldman-Fox con inserti al carburo di tungsteno
Goldman-Fox gum scissors with tungsten carbide inserts, straight



Forbicine per Gengive
Gum Scissors

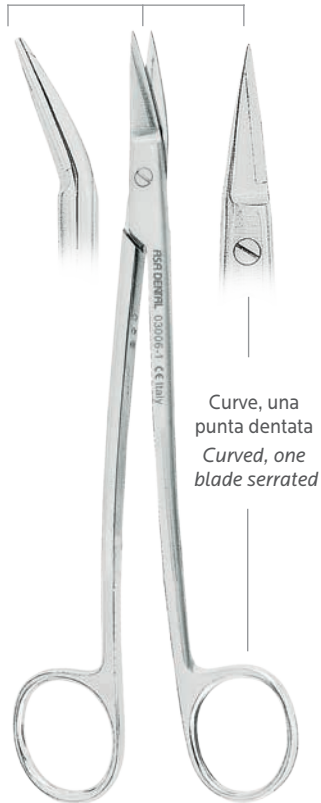

Curve, una punta dentata
Curved, one blade serrated

0306-1
Fig. 1
Dean
cm. 17



Curve, con inserti al carburo di tungsteno
Curved, with tungsten carbide inserts

0306-1TC
Fig. 1TC
Dean
cm. 17



Curve
Curved

0302-1
Fig. 1
Neumann
cm. 12,5



Curve, una punta dentata
Curved, one blade serrated

0307-1
Fig. 1
La Grange
cm. 10,5



Rette
Straight

0308-1
Fig. 1
Quinby
cm. 12,5



Curve
Curved

0308-2
Fig. 2
Quinby
cm. 12,5

Forbicine per Gengive Gum Scissors



Rette
Straight

0309-1
Fig. 1
Kelly
cm. 16

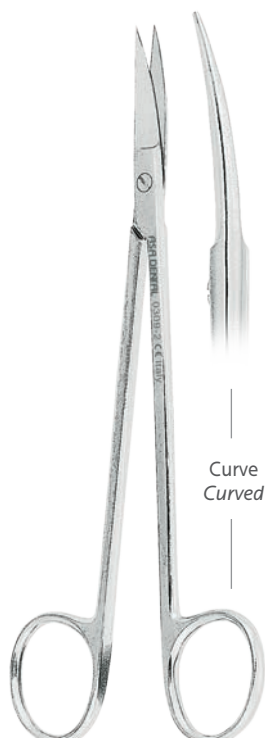

Curve
Curved

0309-2
Fig. 2
Kelly
cm. 16

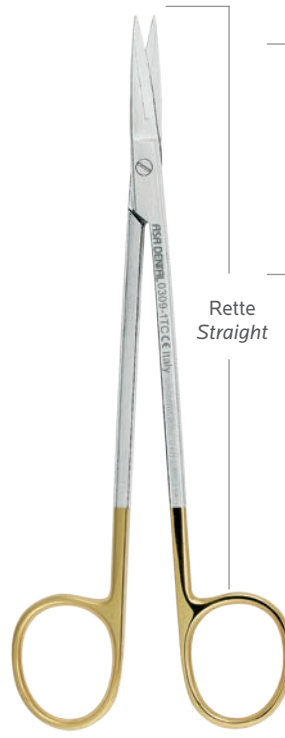

Rette
Straight

0309-1TC
Fig. 1TC
Kelly
cm. 16

Con inserti al carburo
di tungsteno
With tungsten
carbide inserts



Curve
Curved

0309-2TC
Fig. 2TC
Kelly
cm. 16



Angolari, una
punta dentata
Angular, one
blade serrated

0310-1
Fig. 1
Locklin
cm. 16,5



Angolari, una
punta dentata
Angular, one
blade serrated

0310-2
Fig. 2
Locklin
cm. 16,5



Angolari, con inserti al
carburo di tungsteno
Angular, with
tungsten
carbide inserts

0310-1TC
Fig. 1TC
Locklin
cm. 16,5

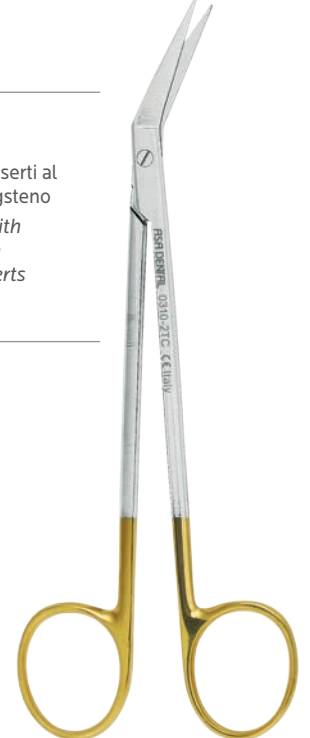

0310-2TC
Fig. 2TC
Locklin
cm. 16,5



Forbicine per Gengive
Gum Scissors



Le forbici Asa Dental garantiscono precisione al taglio e resistenza all'usura
Asa Dental scissors provide better cutting quality and wear resistance

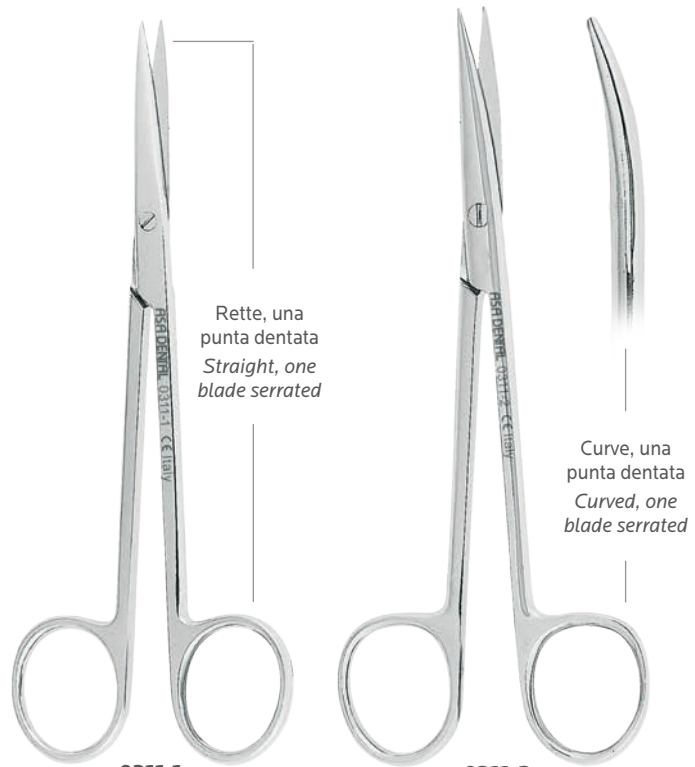

Rette, una punta dentata
Straight, one blade serrated

Curve, una punta dentata
Curved, one blade serrated

0311-1
Fig.1
Sullivan
cm. 14,5

0311-2
Fig.2
Sullivan
cm. 14,5



0303-1
Forbicine per suture Noyes/Castroviejo con punte curve e sottili
Noyes/Castroviejo gum scissors with curved and very thin beaks



Curve, punte molto sottili
Curved, very thin beaks

0303-1
Fig. 1
Noyes (Castroviejo)
cm.12



Curve, punte acute
Curved, sharp beaks

0312-1
Fig.1
Westcott
cm.11



Curve, punte arrotondate
Curved, blunt beaks

0312-2
Fig. 2
Westcott
cm. 11



Curve, punte molto sottili
Curved, very thin beaks

0313-1
Fig. 1
cm.14,5

Forbicine per Chirurgia Surgical Scissors



0320-2
Forbici di Spencer per
suture profonde
Spencer ligature scissors
for deep suture

Forbici per legature Ligature scissors



0320-1
Fig. 1
Spencer
cm.9



0320-2
Fig. 2
Spencer
cm.13



0325-1
Fig. 1
Mayo
cm. 14,5



0325-2
Fig. 2
Mayo
cm.14,5

Forbici per separazioni Dissecting scissors



0321-1
Fig. 1
Metzenbaum
cm.14,5

Rette
Straight



0321-2
Fig. 2
Metzenbaum
cm.14,5

Curve
Curved



0322-1
Fig. 1
Metzenbaum-Delikat
cm. 14,5

Rette
Straight

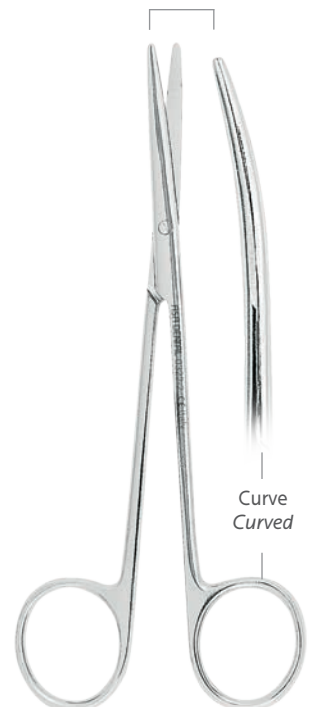

0322-2
Fig. 2
Metzenbaum-Delikat
cm. 14,5

Curve
Curved



Forbicine per Chirurgia
Surgical Scissors

Forbici per separare
Dissecting scissors



Rette
Straight

0328-1
Stevens
cm. 11,5



Curve
Curved

0328-2
Stevens
cm. 11,5



Punte stondate
rette
Rounded straight
beaks

0329-1
Stevens
cm. 11,5



Punte stondate,
curve
Rounded curved
beaks

0329-2
Stevens
cm. 11,5



Forbici per
separare, rette
Dissecting scissors,
straight

0330-1
Stevens
cm. 11,5



Forbici per
separare, curve
Dissecting scissors,
curved

0330-2
Stevens
cm. 11,5

Manici per Bisturi Scalpel Handles



0350-3
Manico in acciaio per bisturi
Stainless steel scalpel handle

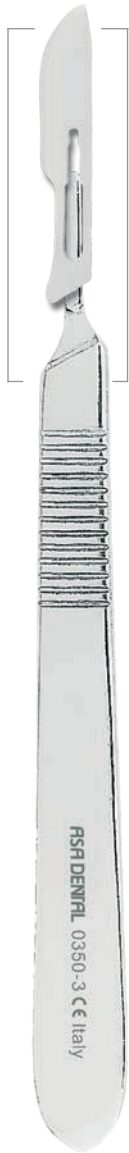

0350-3
Fig. 3



0350-3G
Fig. 3G



0350-8
Fig. 8



0350-7
Fig. 7



0350-5
Fig. 5



0350-5A
Fig. 5A

Lame per Bisturi * Scalpel Blades *

Confezione da 100 pezzi
Box of 100



0351-12D
Fig. 12D



0351-15C
Fig. 15C

A doppio taglio
Double cutting edge



0351-10
Fig. 10



0351-11
Fig. 11



0351-12
Fig. 12



0351-13
Fig. 13



0351-15
Fig. 15



Manici per Bisturi
Scalpel Handles

0335-1
16 cm



Bisturi a lama orientabile
Orientable blade scalpel handle

Pinza Toglilame Bisturi
Scalpel Blades Remover



Pinza togli lama
Scalpel blade remover

S0352
Serie composta da pinza togliame più manico per bisturi
Kit of scalpel blade remover and orientable blade scalpel handle



0352
16,5 cm

Bisturi monouso *
Disposable scalpels *

Confezioni da 10 pz.
Box of 10



0371-10



0371-11



0371-12



0371-15



0371-11
Bisturi monouso
Disposable scalpel

Manici per Bisturi Scalpel Handles



0360-4
Fig. 4

Lame per Bisturi * Scalpel Blades *

Confezione da 100 lame
Box of 100 blades



0361-20
Fig. 20



0361-21
Fig. 21



0361-22
Fig. 22



0361-23
Fig. 23



0361-24
Fig. 24

Manico per micro lame Micro-Blade holder



0365-1
cm. 13,5

Micro lame * Micro-Blades *

Confezione da 25 pezzi sterili
Box of 25 sterile



0366-4
Fig. 4



0366-7
Fig. 7



0365-1
Manico per microlame
con bisturi fig.7
Handle for micro-blade
with blade fig.7



Porta Aghi
Needle Holders



0400-14
Porta aghi Olsen-Hegar con forbici
Olsen-Hegar needle holder and scissors combined



0400-14
Olsen-Hegar
cm. 14

Porta aghi
con forbice
Needle holder and scissors combined

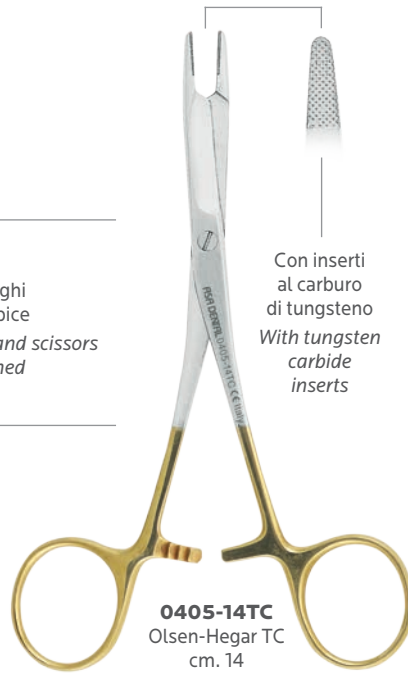

0405-14TC
Olsen-Hegar TC
cm. 14

Con inserti
al carburo
di tungsteno
With tungsten carbide inserts



0404-14
Baumgartner
cm.14,5



0410-15
Crile-Wood
cm. 15



0415-15TC
Crile-Wood TC
cm. 15

Con inserti
al carburo
di tungsteno
With tungsten carbide inserts



0403-17
Adson
cm. 17,5

Porta Aghi
Needle Holders

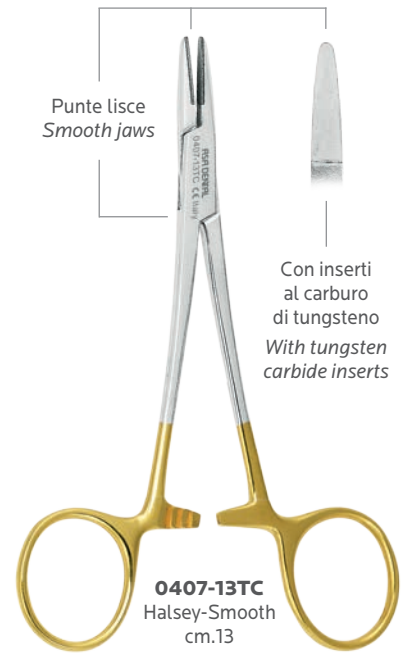

Porta Aghi Needle Holders

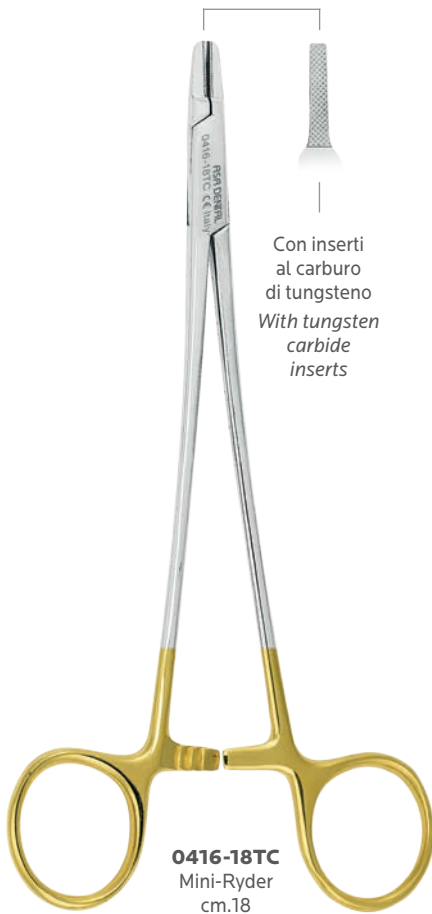

0416-18TC
Porta aghi Mini-Ryder con inserti al carburo di tungsteno
Mini-Ryder needle holder with tungsten carbide inserts

Porta Aghi Needle Holders



Porta aghi
con forbice
*Needle holder and scissors
combined*



Con inserti
al carburo
di tungsteno
*With tungsten
carbide inserts*



Con inserti
al carburo
di tungsteno
*With tungsten
carbide inserts*

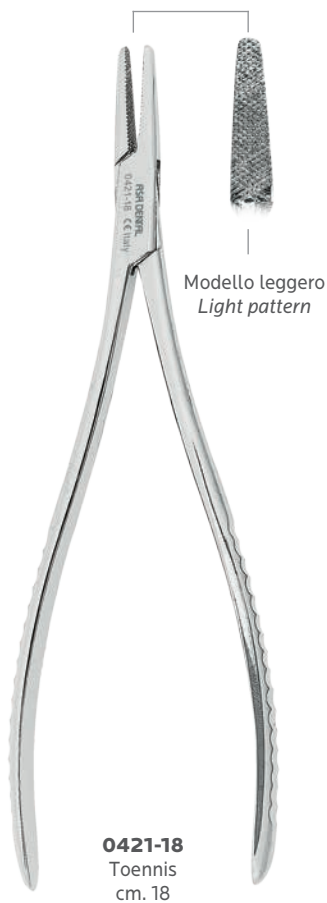

Modello leggero
Light pattern

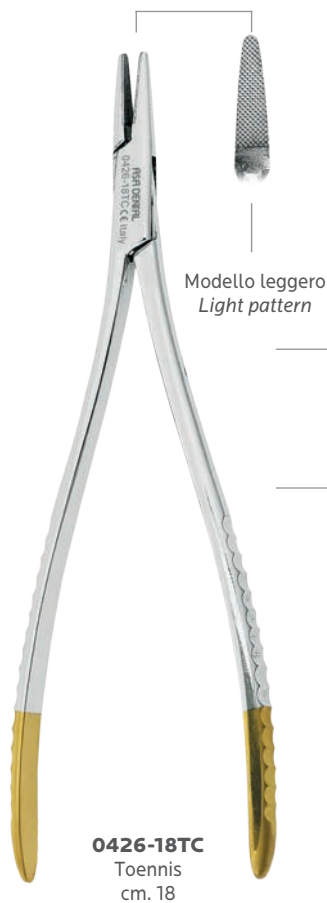

Modello leggero
Light pattern

Con inserti al carburo di tungsteno
With tungsten carbide inserts



Porta Aghi Needle Holders



Movimento
leggero
*Smooth
action*

0432-17
Lichtenberg
cm.17



Con inserti
al carburo
di tungsteno
*With tungsten
carbide inserts*

0437-17TC
Lichtenberg
cm.17



0422-19
Eiselberg-Mathieu
cm. 19,5



0433-16
Arruga
cm. 16

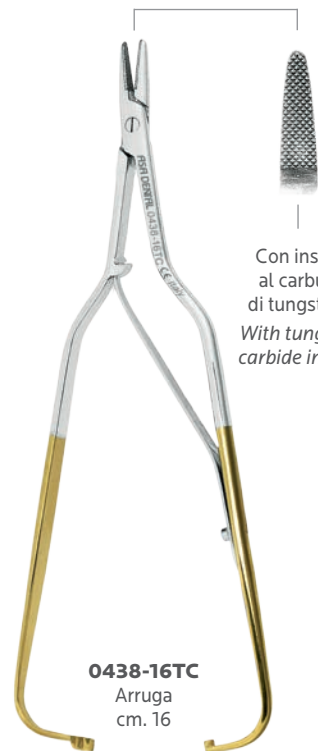

Con inserti
al carburo
di tungsteno
*With tungsten
carbide inserts*

0438-16TC
Arruga
cm. 16

Porta Aghi Needle Holders



0430-14
Porta aghi Mathieu con punte molto sottili
Mathieu needle holder with very thin jaws

Porta aghi prodotti con molle progettate per garantire una massima funzionalità e durata nel tempo
Special spring design for optimum operation and reliability



0430-14
Mathieu
cm. 14



0431-14
Mathieu
cm. 14

Porta aghi con forbice Needle holder and scissors combined



0432-14
Mathieu
cm. 14



0430-17
Mathieu
cm. 17



0431-17
Mathieu
cm. 17



Con inserti al carburo di tungsteno
With tungsten carbide inserts

0432-14TC
Mathieu
cm. 14



Porta aghi con inserti al carburo di tungsteno
Needle holders with tungsten carbide inserts



0435-14TC
Mathieu TC
cm. 14



0436-14TC
Mathieu TC
cm. 14



0435-17TC
Mathieu TC
cm. 17



0436-17TC
Mathieu TC
cm. 17



0450-18TC
Micro-Barraquer TC
cm. 18

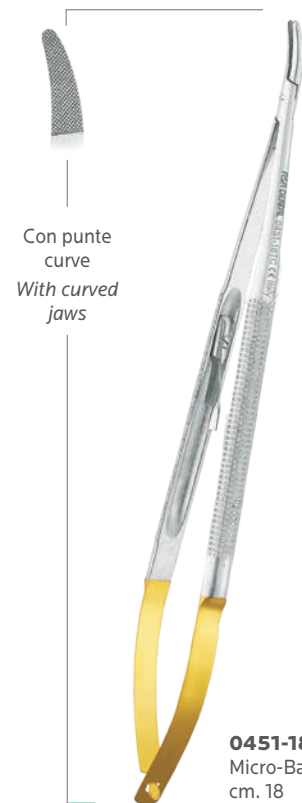

Con punte
curve
With curved
jaws

0451-18TC
Micro-Barraquer TC
cm. 18

Porta Aghi
Needle Holders



0440-14
Castroviejo
cm. 14



Con punte curve
With curved jaws

0441-14
Castroviejo
cm. 14



0443-14
Castroviejo
cm. 14/60°

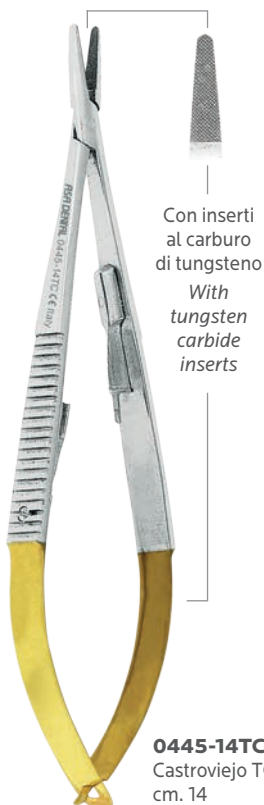

Con inserti al carburo di tungsteno
With tungsten carbide inserts

0445-14TC
Castroviejo TC
cm. 14

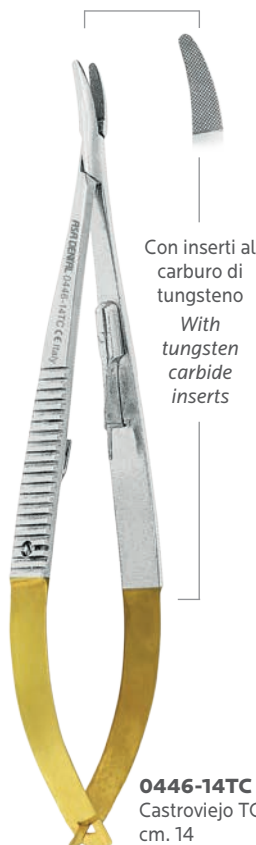

Con inserti al carburo di tungsteno
With tungsten carbide inserts

0446-14TC
Castroviejo TC
cm. 14

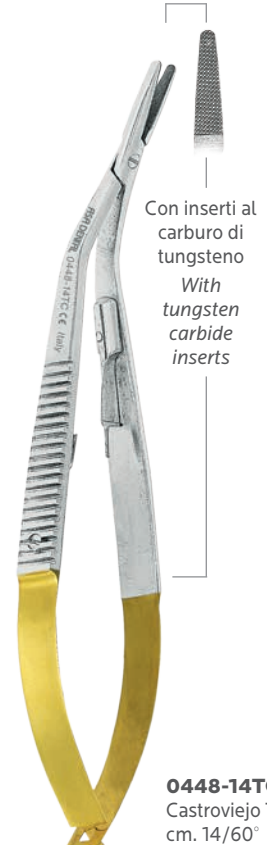

Con inserti al carburo di tungsteno
With tungsten carbide inserts

0448-14TC
Castroviejo TC
cm. 14/60°



Porta Aghi Needle Holders



0442-13
Castroviejo
cm. 13



Con inserti al
carburo di
tungsteno
*With tungsten
carbide
inserts*

0447-13TC
Castroviejo
cm. 13



Punte lisce
Smooth jaws

0442-13L
Castroviejo
cm. 13



Punte lisce
Smooth jaws

0444-12L
Castroviejo
Barraquer
cm. 12



0440-18
Castroviejo
cm. 18



Con inserti al
carburo di
tungsteno
*With tungsten
carbide
inserts*

0445-18TC
Castroviejo
cm. 18



Con punte
curve
*With curved
jaws*

0441-18
Castroviejo
cm. 18



Con inserti
al carburo di
tungsteno
*With tungsten
carbide
inserts*

0446-18TC
Castroviejo
cm. 18

Siringhe dentali pieghevoli Folding type dental Syringes

NEW



0483-1

senza aspirazione con filettatura metrico decimale
no aspirating syringe with metric thread



0483-2

con puntale a cavatappi,
filettatura metrico decimale
*with cork screw tip
and with metric thread*



0483-3



0480-5

Siringhe autoaspiranti
con filettatura metrico
decimale
*Self aspirating syringes
with metric thread*



0480-6



Siringhe Dentali Dental Syringes

0480-1
Siringa a tre anelli con ago montato
Three O Rings syringe with needle



0480-3
Caricamento della tubo fiala
Phial-pipe setting



0480-1

Puntali a cavatappi
Cork screw tip



0480-P1
Puntale di ricambio
filettatura metrico decimale
*Spare cap
with metric thread*

per/for
0480-1, 0480-2
0480-3, 0480-4



0480-2



Pieghevole, puntale
a cavatappi
*Folding type, cork
screw tip*

0480-3



0480-P2
Puntale di ricambio
filettatura Withworth
*Spare cap
with Withworth thread*

Puntale a
cavatappi
*Cork screw
tip*



0480-4

Siringhe per Anestesia Intraligamentale Intra-Ligamental Syringes



0481-8

Siringa in acciaio inox
Stainless steel syringe

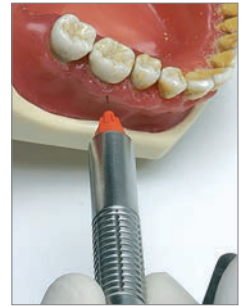

0481-8
Siringa per anestesia
intra-ligamentale
Intra-ligamental syringe

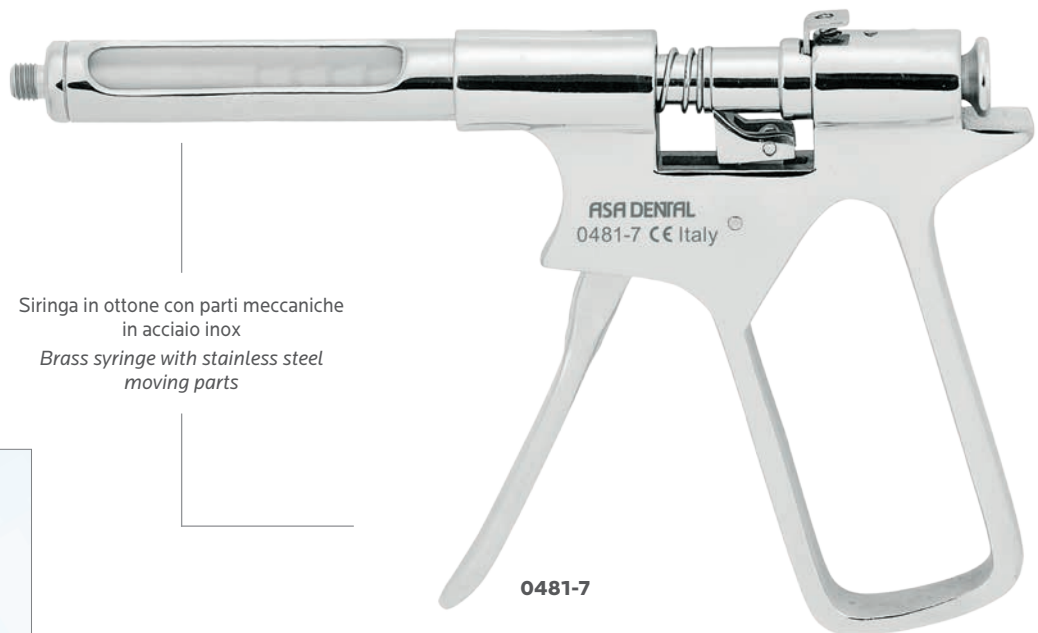

0481-7

Siringa in ottone con parti meccaniche
in acciaio inox
Brass syringe with stainless steel
moving parts



0481-7
Siringa per anestesia intra-ligamentale
Intra-ligamental syringe



0481-T1
Protezione in plastica autoclavabile
Autoclavable plastic protection sleeve



0482-1
Base di appoggio per siringa
Syringe stand



Pinze Emostatiche
Haemostatic Forceps



0520-1
Fig. 1
Crile
cm. 14



0520-2
Fig. 2
Crile
cm. 14

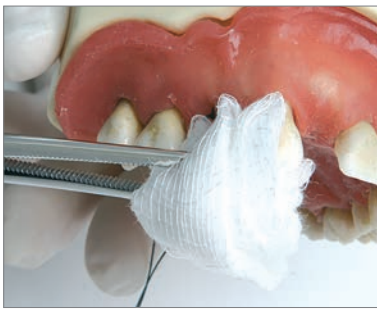

0530-1
Pinzetta emostatica portagarze Kocher
Kocher haemostatic forceps also for bandages



0530-1
Fig. 1
Kocher 1x2
cm. 14



0530-2
Fig. 2
Kocher 1x2
cm. 14



0540-1
Fig. 1
Pean
cm. 14



0540-2
Fig. 2
Pean
cm. 14

Pinze Emostatiche
Haemostatic Forceps



0500-1
Pinza emostatica portagarze
Halstead-Mosquito
Halstead-Mosquito haemostatic forceps



0500-1
Fig. 1
Halstead-Mosquito
cm. 12



0500-2
Fig. 2
Halstead-Mosquito
cm. 12



0505-1
Fig. 1
Halstead-Mosquito 1x2
cm. 12



0505-2
Fig. 2
Halstead-Mosquito 1x2
cm. 12



0510-1
Fig. 1
Kelly
cm. 14



0510-2
Fig. 2
Kelly
cm. 14



Pinze Emostatiche
Haemostatic Forceps



0501-1
Fig. 1
Micro-Mosquito
cm. 10



0501-2
Fig. 2
Micro-Mosquito
cm. 10

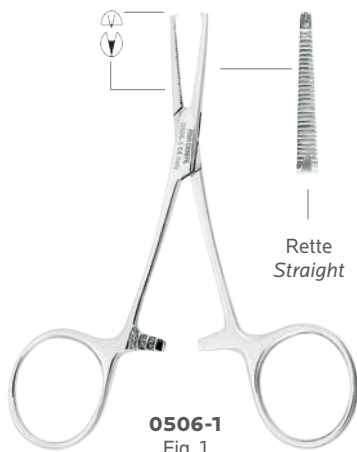

0506-1
Fig. 1
Micro-Mosquito 1x2
cm. 10



0506-2
Fig. 2
Micro-Mosquito 1x2
cm. 10



0515-1
Fig. 1
Hartmann
cm. 10



0515-2
Fig. 2
Hartmann
cm. 10

Pinze per Pannilino Towel Clamps



0550-1
Fig. 1
Backhaus
cm. 8



0550-2
Fig. 2
Backhaus
cm. 11



0550-3
Fig. 3
Backhaus
cm. 13



0680
Schaedle
cm. 9



0681
Jones
cm. 9



Pinze Porta Tamponi
Dressing Forceps

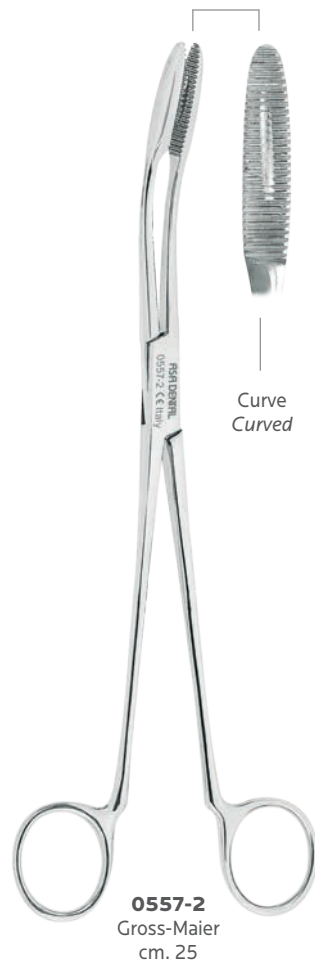

Apribocca - Pinze Tirlingua
Mouth Gags - Tongue Forceps



Per adulti
For adults

1870-2
Molt
cm. 14



Per bambini
For children

1870-1
Molt
cm. 11



1871-1
Roser-Koenig
cm. 16



1871-2
Roser-Koenig
cm. 19



0560
Collin
cm. 16



0561-R

0561
Young
cm. 17



Divaricatori - Abbassalingua
Retractors - Tongue Depressors

Divaricatori per labbra
Lip retractors



2601
Columbia
cm. 14,5



2602-1
Sternberg
cm. 14



2602-2
Sternberg
cm. 16



2602-3
Sternberg
cm. 14



2609-2
Oringer medium
cm. 11 x 8

Abbassalingua
Tongue depressor



2605
cm. 14,5



2606
cm. 14,5



2607
Buchwald
cm. 17



2608
Brünings
cm. 19

Divaricatore per guance
Cheek Retractor



2604
University of Minnesota
cm. 14

Divaricatori Retractors



cm. 16

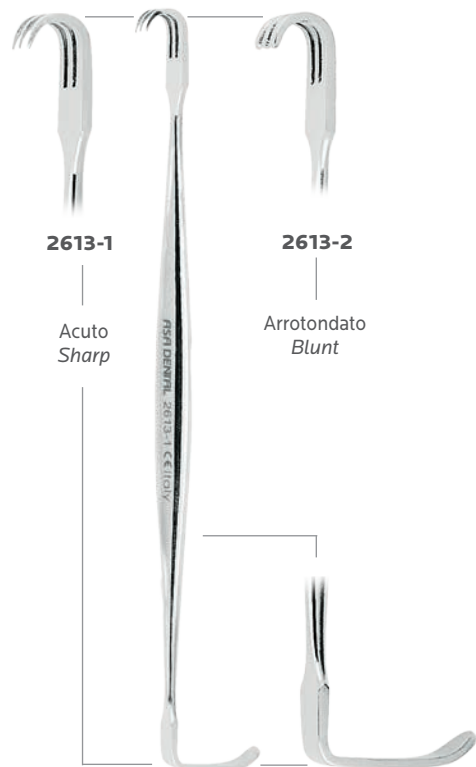

2613-1

Acuto
Sharp

2613-2

Arrotondato
Blunt

Senn-Miller
cm. 16



Kilner
cm. 15



2616-1
Farabeuf
cm. 13

Divaricatori
Retractors



2617-1

Retto, acuto
Straight, sharp

Williger
cm. 13



2617-2

Sinistro, acuto
Left, sharp

Williger
cm. 13



2617-3

Destro, acuto
Right, sharp

Williger
cm. 13



2618-1

Retto, arrotondato
Straight, blunt

Williger
cm. 13



2618-2

Sinistro, arrotondato
Left, blunt

Williger
cm. 13

Divaricatori Retractors



Divaricatori per
spina nasalis
*Ramus retractors
for nasal spine*



Divaricatori
Retractors



Middeldorpf



mm. 14x17

2620-1
cm. 21,5



mm. 20x22

2620-2
cm. 22



mm. 26x30

2620-3
cm. 23,5



2627
cm. 20



2628-1
cm. 23,5

Divaricatore labiale
Labial retractors

Sonde Seno Mascellare
Antrum Probes



2650-02
Bowman
cm. 12,5

2650-08
Bowman
cm. 13,5

Fig.	Ø mm.	Art.n.
1/2	0,9/1,1	2650-02
7/8	1,8/1,9	2650-08

Sonde per il seno mascellare
Antrum probes

Fig.	Ø mm.	Art.n.
1	1	2651-1
2	2	2651-2



2651-1
cm. 14

2651-2
cm. 14

Pinzette Chirurgiche Tissue Pliers



0620-1
Pinzetta chirurgica Adson
con punte sottile
Adson tissue pliers with thin tips



0623-1
Pinzetta chirurgica dritta con
punte molto fini
*Tissue pliers with very thin
tips, straight*



0620-1
Fig. 1
Adson
cm. 12

0621-1
Fig. 1
Adson 1x2
cm. 12

0622-1
Fig. 1
Micro-Adson 1x2
cm. 12

0622-2
Fig. 2
Micro-Adson 1x2
cm. 15

0623-1
Molto fine
Very thin
cm. 10

0624-1
Micro-Adson
cm.12

0624-2
Micro-Adson
cm.15



Pinzette Chirurgiche - Pinzette per Sutura
Tissue Pliers - Suture Pliers



0625-1
Fig. 1
cm. 15
Pinzette per sutura
Suture pliers



0626-1
Adson Brown
non traumatic
cm. 12



0630-1
Fig. 1
Semken-Taylor
cm. 12,5



0630-2
Fig. 2
Semken-Taylor
cm. 12,5



0631-1
Fig. 1
Semken-Taylor 1x2
cm. 12,5



0631-2
Fig. 2
Semken-Taylor 1x2
cm. 12,5

Pinzette Chirurgiche Tissue Pliers



0645-1
Pinzetta chirurgica per lembi con punte estremamente sottile
Tissue pliers with very thin tips

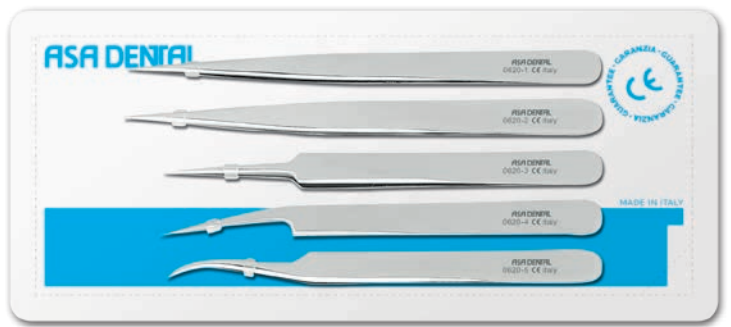

S0645
Serie da 5 pezzi
Set of 5

Punte molto sottili
Very thin tips



0645-1
Fig. 1
cm. 12,5



0645-2
Fig. 2
cm. 12



0645-3
Fig. 3
cm. 11,5



0645-4
Fig. 4
cm. 11,5



0645-5
Fig. 5
cm. 11,5



Pinzette Chirurgiche
Tissue Pliers



0635-1
Fig. 1
cm. 13



0635-2
Fig. 2
cm. 14



0635-3
Fig. 3
cm. 15



0635-4
Fig. 4
cm. 18



0635-5
Fig. 5
cm. 20,5

Cannule Aspirasaliva Chirurgiche in Acciaio Surgical Stainless Steel Saliva Ejectors



2902-S
cm. 18 - ø 3 mm



2902-M
cm. 18 - ø 4 mm



2902-L
cm. 18 - ø 5 mm



2904-12
Fig. 12FR
Frazier
cm. 15 - ø 4 mm



2904-10
Fig. 10FR
Frazier
cm. 15 - ø 3,3 mm



2904-8
Fig. 8FR
Frazier
cm. 15 - ø 2,7 mm



2904-6
Fig. 6FR
Frazier
cm. 15 - ø 2 mm

Cannule Aspirasaliva Chirurgiche Surgical Aspirator Tips

2905-AD
Adattatore sterilizzabile in autoclave
per cannula 2905-155
Autoclavable adaptor for 2905-155



2905-155
Cannula sagomata universale per aspiratore chirurgico,
sterilizzabile in autoclave
Aspirator tips specially shaped for surgical use, autoclavable



SEDE LEGALE HEAD OFFICE:

Asa Dental S.p.A. uninominale

Via Valenzana di Sopra, 60 - Bozzano - 55054 Massarosa (Lu) - Italy

Tel. +39 0584 938305 - 93363 - 938306

Fax +39 0584 937167

asadental@asadental.it

www.asadental.it - www.asadental.com

UNITÀ PRODUTTIVE OPERATIVE UNITS:

Via del Crocicchio, 69 - Bozzano - 55054 Massarosa

Via D. Rontani, 50 - Bozzano - 55054 Massarosa

Lucca - Italy

STABILIMENTI PRODUTTIVI PLANTS:

Via delle Piagge, 1/A - Martia - 55014 Capannori

Lucca - Italy

Via Fierla, 13 - Z.I. - 33085 Maniago

Pordenone - Italy

SEDE U.S.A. U.S.A. BRANCH:

Asa Dental USA Corp.

131 Jericho Turnpike, Suite 202

Jericho - New York 11753 - USA

SEDE CINA CHINA BRANCH:

Asa Dental CHINA CO., LTD

Room 315, Huaying Building,

Zhong xin Avenue

Tianjin Airport Economic Area

Tianjin - China



ASA DENTAL

MAKE PEOPLE SMILE

